

Accuphase

STEREO CONTROL CENTER

C-2110

- Revolutionary AAVA volume control
- Separate power transformers for left and right channels
- Selectable preamp gain
- Independent phase selection for each input position
- Fully modular construction with individual left/right amplifier units on motherboard
- Logic-controlled relays for shortest signal paths
- Tone controls designed for optimum sound quality
- Option board slots provide versatility for handling digital input signals or analog record playback





Further improved AAVA volume control provides ultra-smooth action – Adjust the listening level without any losses in sound quality or performance. Complete dual mono construction features separate power supplies, plus separate AAVA unit amplifier modules on a motherboard. Individual control of phase for each input position. Option boards enable reproduction of digital input signals and high-grade playback of analog records.

Ever since being introduced in the model C-2800, Accuphase's ground-breaking AAVA (Accuphase Analog Vari-gain Amplifier) volume control has undergone further refinements, reflecting accumulated technical know-how. The result has made an excellent idea even better, and it has helped Accuphase preamplifiers maintain their position as undisputed leaders and reference products both in terms of sound quality and performance.

The C-2110 is a successor to the model C-2000. It inherits advanced design technology from the C-2810 and C-2410 and features AAVA volume control with the same outstanding specifications and configuration but further augmented circuitry. AAVA is a new kind of volume control that assures excellent sonic

performance by integrating the amplification and volume control tasks and eliminating all mechanical contact points from the signal path. The fact that the music signal no longer has to pass through any variable resistors brings a number of distinct design advantages and enhances sonic purity. Another benefit of AAVA is that only highly reliable electronic components are used, ensuring that the outstanding performance and sound quality of the amplifier will remain undiminished for many years to come. In actual operation, the volume knob on the front panel which is only used for position detection has the same feel as on a conventional amplifier.

The power supply section of the C-2110 employs separate transformers, while filtering capacitors and

other parts of the power supply are also duplicated for left and right. What's more, the AAVA circuitry, balanced output circuits, and other unit amplifiers are also entirely separate for the two channels, arranged on a high-quality motherboard. This fully monaural construction prevents unwanted crosstalk and interaction both on the electrical and the physical plane.

Most of the internal circuitry of the C-2110 is devoted to AAVA, but there are also tone controls, a loudness compensator, recorder connection support and other convenient features. The PHASE button lets the user specify the phase setting for each input position separately, and EXT PRE connectors offer further enhanced flexibility. The overall result is a versatile analog preamplifier of immense appeal.

Further Improved AAVA (Accuphase Analog Vari-gain Amplifier) Volume Control

AAVA is a radically different volume control principle that eliminates all variable resistors from the signal path and provides top-notch performance and sound quality. Because the music signal is not affected by changes in impedance, high signal-to-noise ratio and low distortion are maintained at any volume control setting.

Volume control resolution

AAVA adjusts the listening volume by means of 16 weighted V-I converter amplifiers which are controlled by current switches. The number of possible volume steps set by the combination of these converter amplifiers is 2 to the power of 16 = 65,536.

Input buffer amps use 5-MCS topology

One of the factors that have a bearing on possible noise in an AAVA arrangement is the input buffer. By connecting five high-performance amps in parallel, drive capability under low-load conditions has been improved, and excellent S/N ratio is assured.

AAVA ensures high S/N ratio and uniform frequency response

Unlike conventional volume controls, AAVA does not introduce a change in impedance at any volume setting. Consequently, there is no deterioration of S/N ratio and frequency response remains totally uniform. The benefits are especially apparent at settings that correspond to normal listening levels, because the sound remains perfectly transparent and the tonal quality is not altered in any way.

No more left/right tracking differences or crosstalk

Because AAVA is an electronic circuit employing fixed-value resistors, there is virtually no left/right tracking error also at low volume levels. Since channels can be kept separate, crosstalk also does not present a problem.

Simple circuit configuration

AAVA unifies the amplifier and volume control functions, resulting in a circuit that is electrically very simple. Long-term reliability is excellent, with performance and sound quality that will remain unchanged also after prolonged use.

AAVA means analog processing

The AAVA circuit converts the music signal from a voltage into a current, switches gain by means of current switches, and then reconverts the current into a voltage. The entire process is carried out in the analog domain.

Same operation feel as a conventional high-quality volume control

The volume control knob position is detected by a dedicated CPU which in turn selects the current switches for AAVA operation. Operating the knob therefore feels exactly the same as with a conventional control, and as before, operation via the remote commander is also possible.

Attenuator and balance control also implemented by AAVA

The functions of the attenuator and the left/right balance control are covered by the AAVA circuit as well, eliminating the need for additional circuit stages. Keeping the configuration simple helps to maintain high performance and sonic purity.

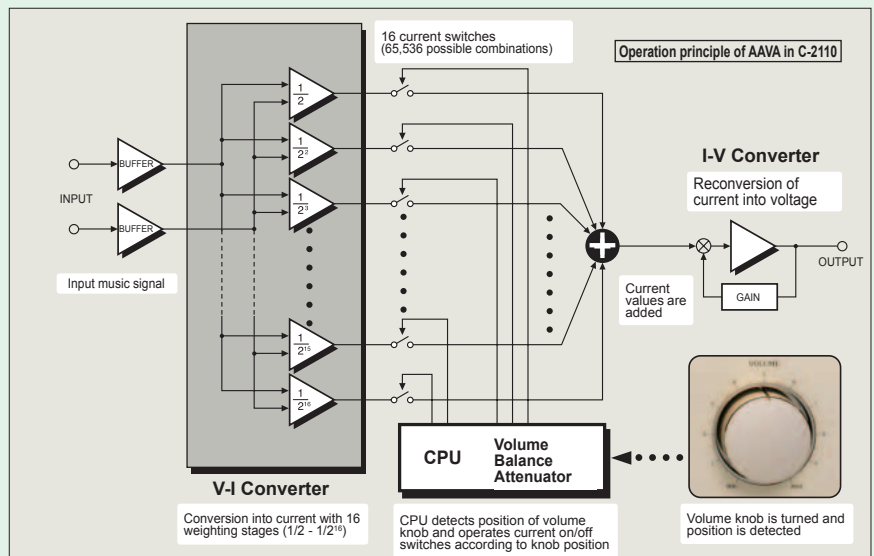

AAVA operation principle

The music signal is converted into 16 types of weighted current by V-I (voltage - current) converting amplifiers [$1/2, 1/2^2, \dots, 1/2^{15}, 1/2^{16}$]. The 16 currents are turned on or off by 16 current switches, and the combination of switch settings determines the overall volume. The switching operation is controlled by a CPU according to the position of the volume control knob. The combined signal current forms a variable gain circuit that adjusts the volume. Finally, the combined current is converted back into a voltage by an I-V (current - voltage) converter.

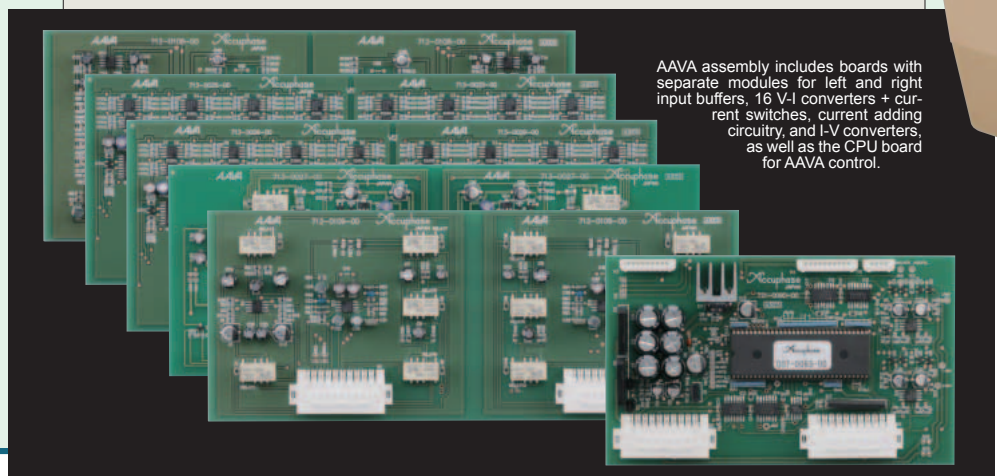

■ **Dual mono construction with separate left and right transformers and separate circuit modules mounted on a board.**

■ **Logic-controlled relays assure high sound quality and long-term reliability.**
Strategically placed relays ensure optimum signal flow and prevent degradation that could occur if the signal has to travel a long way for input and output connection and function switching.

■ **Individual phase control for each input position**
The setting of the PHASE button is memorized for each input separately, and the LED indicator shows the respective status: lit (phase inverted) or out (normal phase).

■ **Selectable preamp gain**
The overall gain of the preamplifier can be set to 12 dB, 18 dB, or 24 dB.

■ **Dedicated headphone amplifier optimized for sound quality**

■ **EXT PRE function allows use of external preamplifier**

■ **Versatile arrangement of balanced and unbalanced input and output connectors**

■ **Two option board slots on rear panel for system expansion**

■ **More versatile features:**

- Provisions for recording and playback with a recorder
- Loudness compensator augments bass impact at low listening volume
- Attenuator (-20 dB)



Balanced input and output connectors

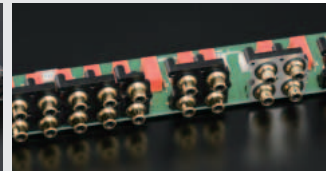

Unbalanced input and output connectors

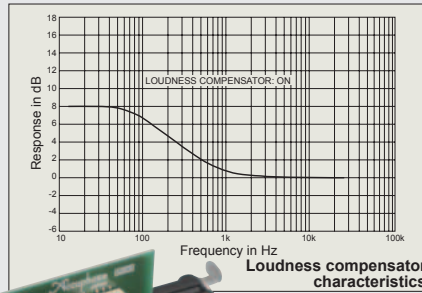

Loudness compensator characteristics

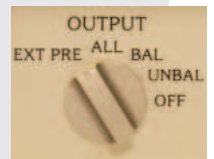

EXT PRE function and phase selector button, with LED indicators

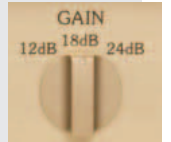

Gain selector

■ **Supplied remote commander RC-200**

Allows volume adjustment, input source switching, and other operations.

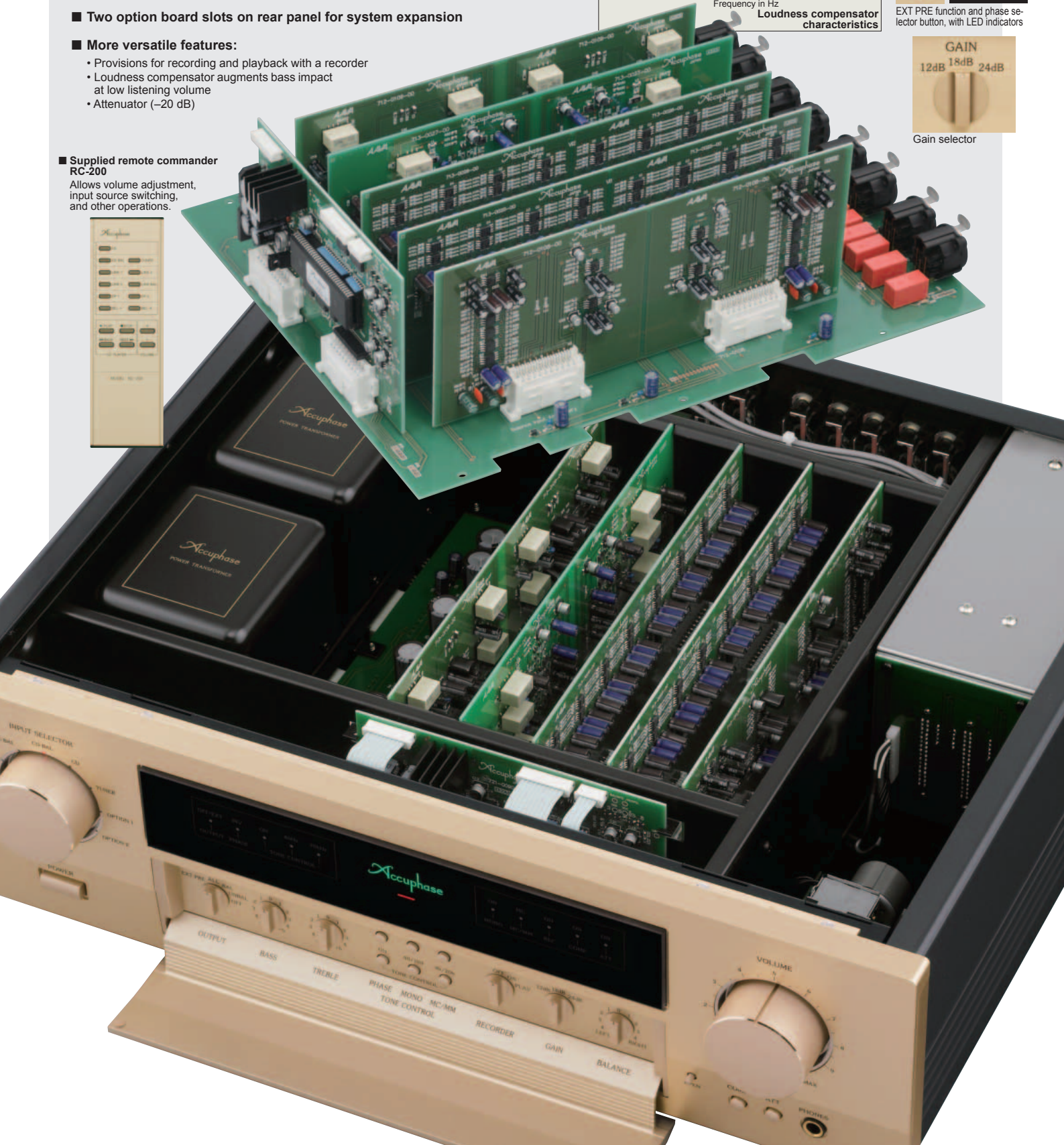
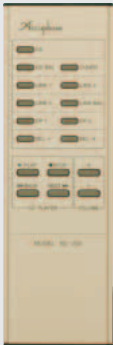

■ Tone controls using summing active filters for optimum sound quality

Bass turnover frequency:
40 or 100 Hz
Treble turnover frequency:
8 or 20 kHz

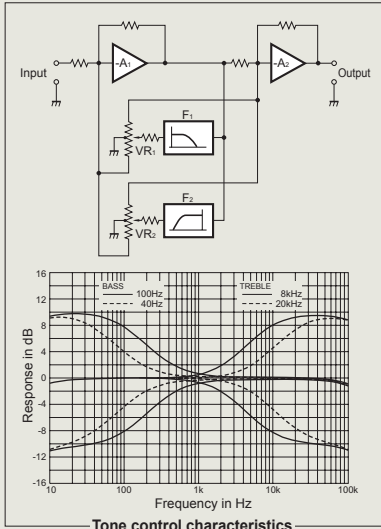

Tone control characteristics

Option Boards

Three types of option boards can be used in the C-2110: the Digital Input Board DAC-20, Analog Disc Input Board AD-20, and Line Input Board LINE-10. These boards can be installed in the rear-panel slots as required.

- It is possible to install two identical boards.
- The Analog Disc Input Board AD-9/AD-10 and the Line Input Board LINE-9 can also be used.
- When using the AD-9/AD-10, the MC/MM button on the front panel of the C-2110 has no effect. MC/MM switching must be performed on the board.

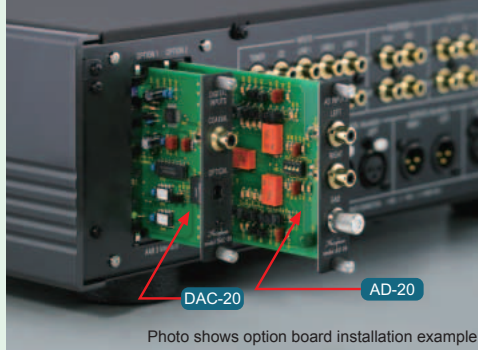

Photo shows option board installation example.

Digital Input Board DAC-20

This board features an MDS (Multiple Delta Sigma) ++ type D/A converter and allows direct digital connection of a CD player, MD or DAT recorder or other component with digital output (sampling frequency up to 96 kHz, 24 bits) for high-quality music reproduction.

- Inputs for coaxial and optical fiber connections are provided.

Analog Disc Input Board AD-20

This board serves for playback of analog records. It contains a high-performance, high-gain phono equalizer.

- MC/MM switching is possible on the front panel of the C-2110.
- Internal DIP switches control MC input impedance and subsonic filter on/off.

MC Gain: 62 dB
Input impedance: 10/30/100 ohms (selectable)

MM Gain: 36 dB
Input impedance: 47 kilohms

Line Input Board LINE-10

This option board provides a set of unbalanced line level inputs.

■ Front panel

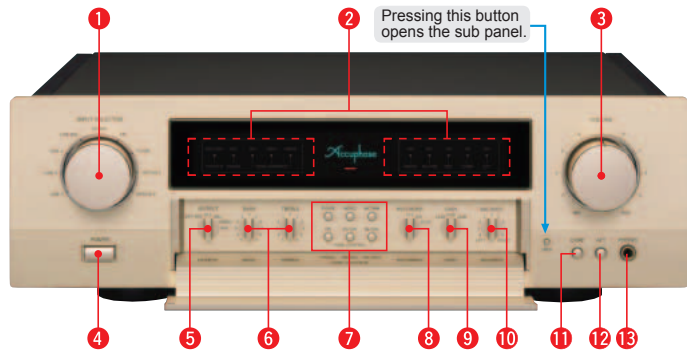

■ Rear panel

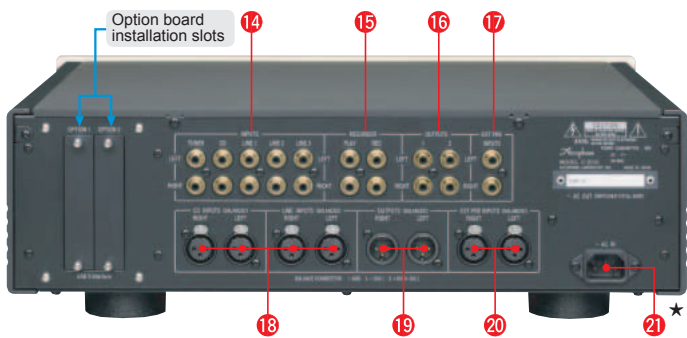

- | | |
|---|---|
| 1 Input selector | 12 Attenuator |
| 2 Function LED indicators | 13 Headphone jack |
| 3 Volume control | 14 Line inputs TUNER CD LINE1, 2, 3 |
| 4 Power switch | 15 Recorder outputs/inputs |
| 5 Output selector | 16 Unbalanced output connectors (2 sets) |
| 6 BASS/TREBLE controls | 17 External preamplifier inputs (unbalanced) |
| 7 Function selector buttons
Phase, stereo/mono, MM/MC, tone control on/off,
40/100 Hz turnover, 8/20 kHz turnover | 18 CD/LINE balanced inputs
① Ground ② Inverted (-)
③ Non-inverted (+) |
| 8 Recorder selector OFF ON PLAY | 19 Balanced outputs |
| 9 Gain selector 12dB 18dB 24dB | 20 External preamplifier inputs (balanced) |
| 10 Balance control | 21 AC power connector* |
| 11 Loudness compensator button | |

Remarks

- * This product is available in versions for 120/230 V AC. Make sure that the voltage shown on the rear panel matches the AC line voltage in your area.
- * The shape of the AC inlet and plug of the supplied power cord depends on the voltage rating and destination country.

Guaranteed Specifications

* Guaranteed specifications are measured according to EIA standard RS-490.

- Frequency Response BALANCED/UNBALANCED INPUT
3 - 200,000 Hz +0, -3.0 dB
20 - 20,000 Hz +0, -0.2 dB
- Total Harmonic Distortion (for all inputs) 0.005%
- Input Sensitivity, Input Impedance

Input	Sensitivity		Input impedance
	For rated output	For 0.5 V output	
BALANCED	252 mV	63 mV	40 kΩ
UNBALANCED	252 mV	63 mV	20 kΩ

- Rated Output Voltage, Output Impedance
BALANCED/UNBALANCED OUTPUT: 2 V, 50 ohms
RECORDER REC: 252 mV, 200 ohms
- S/N Ratio (gain selector: 18 dB)

Input	Input shorted, IHF-A weighting	S/N ratio (EIA)
	S/N ratio at rated output	
BALANCED	109 dB	107 dB
UNBALANCED	109 dB	107 dB

- Maximum Output Level (0.002% THD, 20 - 20,000 Hz)
BALANCED/UNBALANCED OUTPUT: 7.0 V
RECORDER REC: 6.0 V
- LINE Maximum Input Level BALANCED/UNBALANCED INPUT: 6.0 V
- Minimum Load Impedance BALANCED/UNBALANCED OUTPUT: 600 ohms
RECORDER REC: 10 kilohms
- Crosstalk -74 dB or better (10 kHz)
- Residual Noise 0.8 μV or less (A weighting)
- Gain (gain selector: 18 dB) * Gain switchable to 12/18/24 dB
BALANCED/UNBALANCED INPUT → BALANCED/UNBALANCED OUTPUT: 18 dB
BALANCED/UNBALANCED INPUT → REC OUTPUT: 0 dB
- Tone Controls Bass/Treble controls with selectable turnover frequencies
BASS: 40/100 Hz ±8 dB
TREBLE: 8/20 kHz ±8 dB
- Loudness Compensation +6 dB (100 Hz)
- Attenuator -20 dB
- Headphone Jack Suitable impedance: 8-100 ohms
- Power Requirements AC120 V/230 V, 50/60 Hz (Voltage as indicated on rear panel)
- Power Consumption 32 watts
- Maximum Dimensions Width 465 mm (18-5/16")
Height 150 mm (5-7/8")
Depth 405 mm (15-15/16")
- Mass 16.8 kg (37.0 lbs) net
22.0 kg (48.5 lbs) in shipping carton
- Supplied Remote Commander RC-200
Remote control principle: Infrared pulse
Power supply: 3 V DC (IEC R03 batteries × 2)
Maximum dimensions: 56 × 175 × 26 mm
Weight: 153 g (including batteries)

■ Supplied Accessories

- AC power cord
- Audio cable with plugs (1 m)
- Remote commander RC-200



ACCUPHASE LABORATORY, INC.